

Brinsea

Mini EX high performance egg incubator

User instructions

Contents

<u>Section</u>	<u>Subject</u>	<u>Page</u>
1	Introduction	2
2	QUICK REFERENCE	3
3	Unpacking	6
4	Location and Installation	6
5	Digital Control System	8
6	Storage of eggs	10
7	Temperature	10
8	Humidity and Ventilation	11
9	Egg setting	13
10	Egg turning	14
11	Hatching	15
12	Cleaning up	15
13	Servicing and Calibration	16
14	Troubleshooting	18
15	Specification	19

1 Introduction

These instructions detail the operation of your new Mini EX digital incubator. Please read these instructions carefully before setting up your machine to achieve best results and keep these instructions safe for future reference. This document includes recommended procedures for successful hatching but incubation involves the control and manipulation of a large number of factors and in certain circumstances different procedures may be necessary. Your incubator is designed to allow the user to vary the incubation conditions to suit a wide range of species in different ambient conditions and the specific set-up for every situation is beyond the scope of these instructions.

There is a range of books available covering incubation techniques, for more information or to request a book list please don't hesitate to contact us.

Fig. 1 Functional features of the Mini EX and Advance Humidity Pump

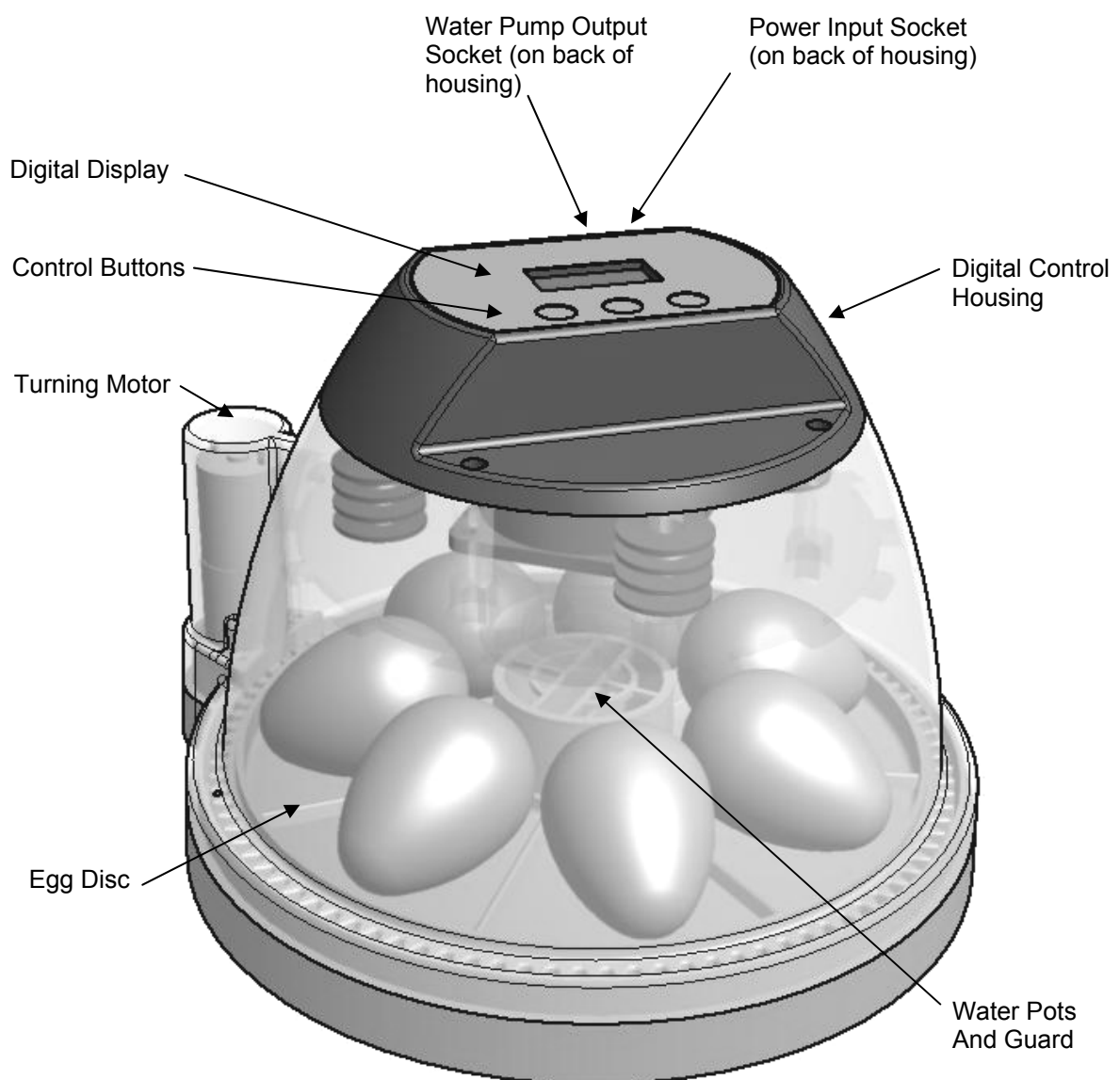

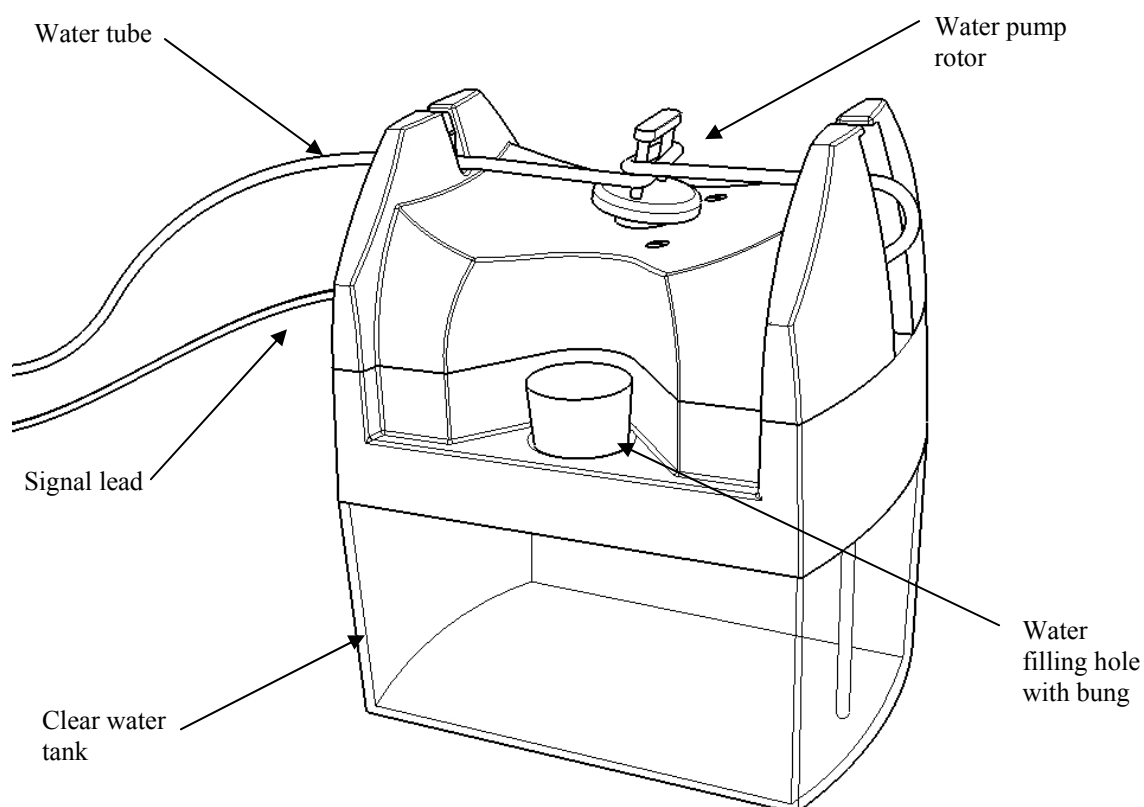

2 Quick Reference (please read relevant section for detail)

This quick reference is intended to allow users to quickly set up the incubator and learn the key features of the control system. Please read the rest of the instructions to obtain a full understanding of each feature.

DO NOT COVER THE INCUBATOR. FOR INDOOR USE ONLY. THE INCUBATOR MUST BE PLACED IN AN AREA NOT SUBJECT TO SPLASHES OF WATER OR WET CONDITIONS AND OUT OF REACH OF ANIMALS AND CHILDREN.

THIS INCUBATOR IS NOT A TOY AND MAY ONLY BE OPERATED BY CHILDREN UNDER ADULT SUPERVISION.





FOR CONTINUED PROTECTION AGAINST FIRE AND ELECTRIC SHOCK ONLY USE THE POWER SUPPLY UNIT AS SUPPLIED WITH THE INCUBATOR. Spares are available from Brinsea Products Ltd.

- 1) Carefully unpack the incubator and pump (section 3)
- 2) Place the egg disc in the base of the incubator, ribbed side up
- 3) Assemble the pump tubes (section 4)
- 4) Insert the pump jack plug into the pump output socket on the back of the control housing
- 5) Insert the power supply unit jack plug into the power input socket on the back of the control housing
- 6) Plug the power supply unit into a convenient mains outlet

The incubator will sound its buzzer and start to warm up.

The pump will not run if the incubator is significantly below the set temperature. This is to prevent the system adding too much water when the top has been opened for inspecting eggs etc.

To access the Main Menu press the – and + buttons simultaneously.

	PRESS BOTH BUTTONS TO UNLOCK THE MAIN MENU
	SELECT THE OPTION / RETURN TO THE MENU.
	GO FORWARD ONE SCREEN / INCREASE THE VALUE / DISPLAY IN CELSIUS.
	GO BACK ONE SCREEN / DECREASE THE VALUE / DISPLAY IN FAHRENHEIT.

Recommended temperatures:

Hens 37.4 – 37.6°C
 Pheasant 37.6 – 37.8°C
 Quail 37.6 – 37.8°C
 Ducks 37.4 – 37.6°C

Parrots:

 Amazons 36.8 – 37.0°C
 Macaws 36.8 – 37.0°C
 Love birds 36.8 – 37.0°C
 African Grey 36.8 – 37.0°C
 Eclectus 36.8 – 37.0°C

Typical incubation period:

99.3 – 99.6°F 21 days
 99.6 - 100°F 23-27 days
 99.6 - 100°F 16-23 days
 99.3 – 99.6°F 28 days
 98.3 – 98.6°F 24-29 days
 98.3 – 98.6°F 26-28 days
 98.3 – 98.6°F 22-24 days
 98.3 – 98.6°F 28 days
 98.3 – 98.6°F 28 days

MAIN MENU – QUICK REFERENCE

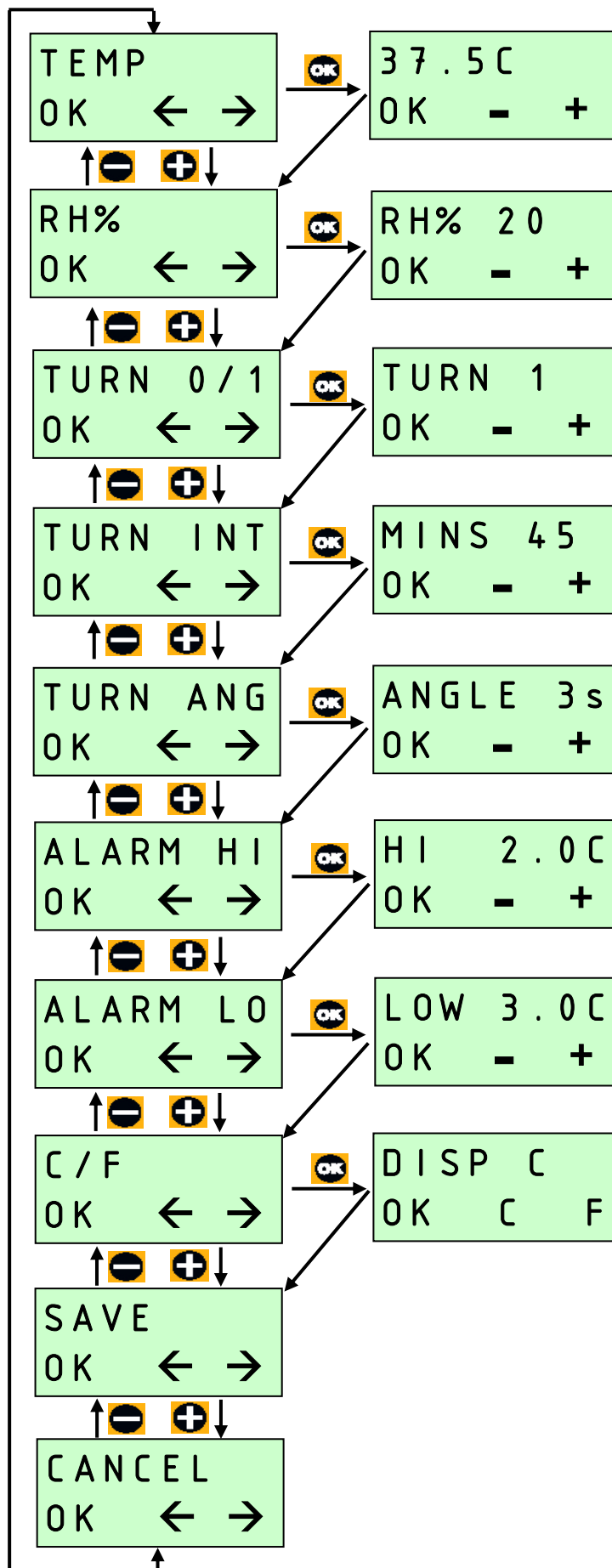

INCUBATION TEMPERATURE.
 RANGE 20.0 – 40.0°C (68.0 – 104.0°F).
 DEFAULT 37.5°C (99.5°F).

RELATIVE HUMIDITY.
 RANGE 20% – 80%.
 DEFAULT 20%.

TURNING MODE.
 SWITCHES THE TURNING SYSTEM
 ON OR OFF.
 DEFAULT ON (1).

TURNING INTERVAL.
 SETS THE DELAY BETWEEN TURNS.
 RANGE 5 – 180 MINUTES.
 DEFAULT 45 MINUTES.

TURNING ANGLE.
 SETS THE ANGLE OF EGG TURNING
 BY HOW LONG THE MOTOR RUNS.
 RANGE 1 – 20 SECONDS.
 DEFAULT 5 SECONDS.

HIGH TEMPERATURE ALARM.
 RANGE 1.0 – 5.0°C (1.8 – 9.0°F) ABOVE
 SET INCUBATION TEMPERATURE.
 DEFAULT 2.0°C (3.6°F).

LOW TEMPERATURE ALARM.
 RANGE 1.0 – 5.0°C (1.8 – 9.0°F) BELOW
 SET INCUBATION TEMPERATURE.
 DEFAULT 3.0°C (5.4°F).

CELSIUS / FAHRENHEIT DISPLAY.
 SWITCHES ALL TEMPERATURE
 FIGURES BETWEEN °C AND °F.
 DEFAULT °C.

SAVE.
 ALL CHANGES ARE SAVED. RETURN
 TO NORMAL OPERATION SCREEN.

CANCEL.
 ALL CHANGES ARE IGNORED.
 RETURN TO NORMAL OPERATION
 SCREEN.

3 Unpacking

Your incubator and pump have been supplied in protective packaging. Please remove all tape, strapping and packing from the incubator and parts. Retain the carton and packing materials to enable the unit to be repacked.

Your incubator will include as standard:

Quantity	Item
1	Incubator (including removable lid)
1	Egg Disc for 12 small eggs
1	Egg Disc for 7 larger eggs
1	Water Pot Guard
1	Power Supply Unit
1	Advance Humidity Pump unit - free standing unit with water pump and signal lead to connect to Mini EX incubator.
1	Clear Water Tank - 1 litre capacity, larger containers may also be used where required.
1	Rubber Bung – to cover water filler hole.
1	Water tube (8 feet) - silicone rubber tube for interconnecting and for peristaltic pump replacement.
1	Rigid water tube (125mm)
2	Evaporating card sheets

- 3.1 Please identify each part and check that they are all present and undamaged. If there are any parts damaged or missing please contact your retailer or Brinsea Products (at the address at the end of the document).
- 3.2 **Please note that the pump capstan on top of the pump unit is deliberately mounted at an angle.**
- 3.3 To register your new Brinsea product please visit www.brinsea.co.uk and follow the link on the right hand side of the home page to qualify for your free 2 year guarantee.
- 3.4 Go to www.Brinsea.co.uk and register as a free member of the Brinsea Email Group to receive the latest news and information such as advance notice about new products, special offers, exclusive competitions and much more.

4 Location and Installation

- 4.1 Your incubator will give best results in a room free from wide temperature variations and with generous ventilation – particularly if several incubators are running at the same time. Ensure that the room temperature cannot drop on a cold night. Ideally thermostatically control the room at between 20 and 25°C (68 and 77°F). **Never allow the room temperature to drop below 17°C (63°F) and ensure that the incubator cannot be exposed to direct sunlight.**
- 4.2 ONLY USE THE POWER SUPPLY UNIT SUPPLIED WITH THE PRODUCT. USE OF A DIFFERENT POWER SUPPLY MAY CAUSE A HAZARD AND WILL INVALIDATE ANY WARANTEE.
- 4.3 Place the incubator and water pump on a flat, level surface that is resistant to moisture and scratching. The base of the incubator must sit flat on the surface as this traps air under it as part of the thermal insulation.

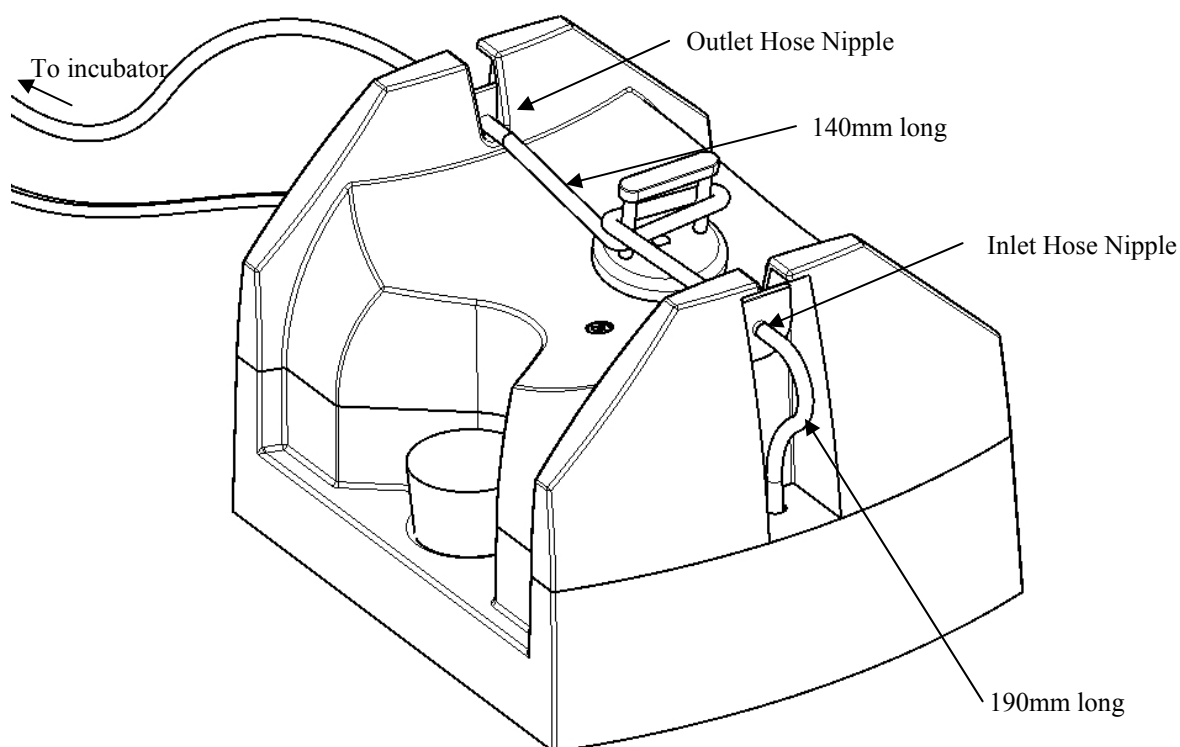

- 4.4 The Advance Humidity Pump is supplied with a length of silicone tube to be fitted around the pump rotor. This length will wear and need periodic replacement. It can also become flattened if left unused for some time because the inside walls of the tube will stick to each other around the rotor and prevent water passing through. Either replace this length of tube with a new 140mm (5 1/2") length or remove it and roll it between finger and thumb to 'un-stick' it.
- 4.5 Cut a 190mm (7 1/2") length of silicone tube and fit to the pump inlet hose nipple (at the right end of the pump). Pass this tube through the hole in the yellow moulding down into the water tank. Allow a loop as shown to prevent kinks.
- 4.6 Cut a suitable length of tube to go between the incubator and the humidity pump e.g. 300mm (12"). Fit one end to the outlet hose nipple on the pump.
- 4.7 Fill the pump water tank with clean water to no higher than the bottom of the yellow moulding.
- 4.8 Fit the rigid plastic tube onto the end of the silicone tube. The time taken for the system to prime can be greatly reduced by sucking some water through most of the length of the tubes. This is easier if one hose nipple is released from its slot so that the tube is loose around the pump rotor.
- 4.9 Pass the rigid plastic tube through the hole in the side of the incubator base. Pull it through and then push it through the hole in the side of the water pot.
- 4.10 Cut a piece of the evaporating card to about 45mm wide (1 3/4") by 120mm long (5") and fold it in half lengthwise. Fit it over the central rib in the water pot and position the end of the rigid plastic tube so that it firmly touches the evaporating card. This will ensure all pumped water is soaked up by the card.

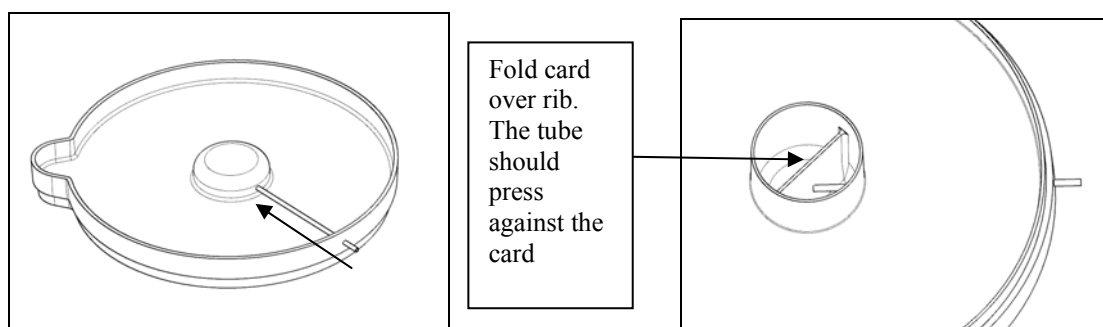

- 4.11 **Fit the water pot guard to prevent chicks jumping in. Small chicks may be at risk of drowning if the water level rises in the pot.**
- 4.12 Fit the egg disc with its ribbed side upwards and replace the lid. Choose the disc for smaller eggs if the eggs can roll correctly when the disc is placed on a flat surface. If the eggs are too large they will be held above the incubator base and will not turn.
- 4.13 Connect the humidity pump jack lead to the pump output socket on the rear of the incubator control housing. Ensure the plug is fitted into the correct socket and pushed fully home.

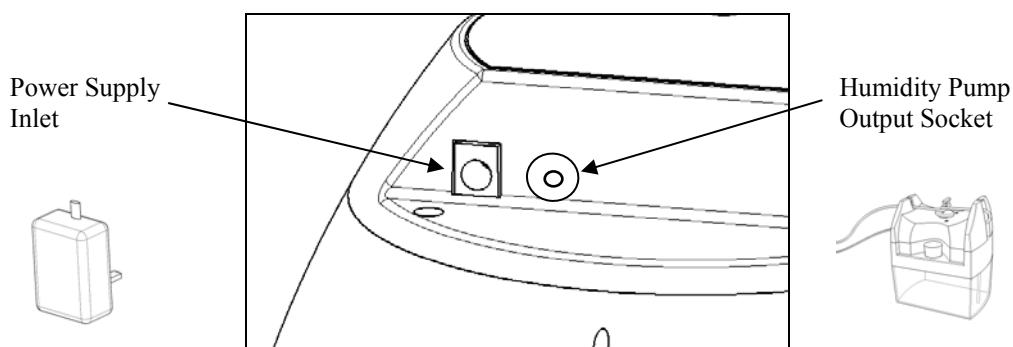

- 4.14 Connect the power supply unit cable to the inlet on the back of the incubator lid. Ensure the connector is pushed fully home in its socket.
- 4.15 Plug the power supply unit into a suitable outlet ensuring that the cable is not pulled tight. The incubator fan will start, the buzzer sound and the LCD display on the temperature control housing will display the air temperature and relative humidity.
- 4.16 Allow the incubator to run for at least an hour to stabilise the temperature before making adjustments or setting eggs.

5 Digital Control System

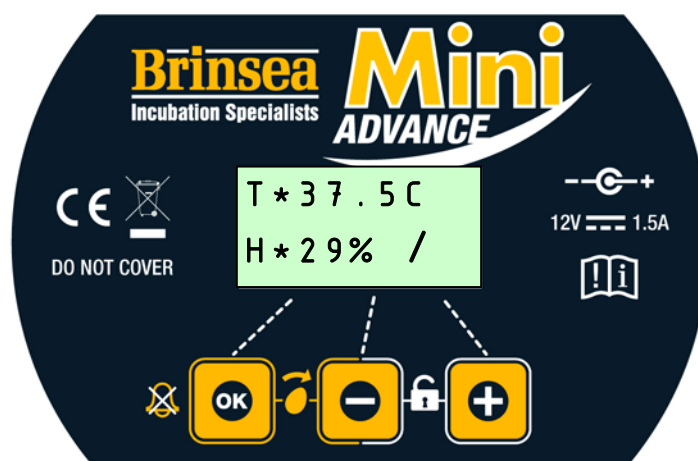

The Mini Advance EX control system utilises a highly accurate, individually calibrated sensor for temperature. Be cautious of low cost analogue or digital thermometers when comparing them with the incubator display reading.

- 5.1 **NORMAL OPERATION** – Temperature, relative humidity and turn system status are continuously displayed.

The asterisk "*" adjacent to the temperature reading shows when the heater power is on. When warming the asterisk will be continuously on, once warmed up the asterisk will slowly flash as the heater is pulsed to maintain the correct temperature. When reducing the temperature setting the asterisk may go off, this is normal.

The asterisk "*" adjacent to the humidity reading shows when the pump output is active (see section 8). The pump output will not come on until the incubator is up to operating temperature and the set humidity level is greater than the measured humidity level in the incubator.

If turning is switched off an "O" flashes at the corner of the display.

If turning is switched on a line "/" symbol rotates at the corner of the display.

- 5.2 **POWER LOSS DISPLAY** – If power has been interrupted due to a power cut (or when first switching on) a "P" is shown flashing in the corner of the display. Press OK for 2 or more seconds to clear the indicator. If the reason for the power loss is not known check the power cable connections are secure.

Once the "P" indicator has been cleared, it is advisable to candle eggs a number of times to check for losses.

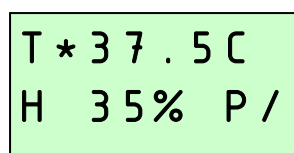

T * 37.5 C
H 35% P /

- 5.3 **HIGH TEMPERATURE ALARM DISPLAY** – If the measured temperature goes up by more than the figure in the ALARM HI screen, the alarm will sound immediately and "H" will be displayed. Press OK to silence the alarm for 30 minutes.

If the high temperature problem rectifies itself the "H" remains on the display to show this has happened. Press OK to clear the indicator. Check the incubator is not (and has not been) in direct sunlight or too near a heat source such as a room heater. It is advisable to candle eggs a number of times after this event to check for losses.

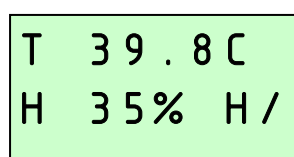

T 39.8 C
H 35% H /

- 5.4 **LOW TEMPERATURE ALARM DISPLAY** – If the measured temperature goes down by more than the figure in the ALARM LO screen, after 30 minutes "L" will be displayed and the alarm will sound. Press OK to silence the alarm for 30 minutes.

If the low temperature problem rectifies itself the "L" remains on the display to show this has happened. Press OK to clear the indicator. Check the incubator is not (and has not been) in a cold draught or that the room temperature has dropped significantly. It is advisable to candle eggs a number of times after this event to check for losses.

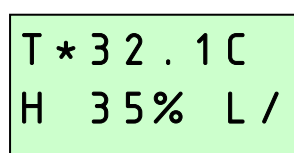

T * 32.1 C
H 35% L /

- 5.5 **CHANGING SETTINGS** – The Main Menu allows the various settings to be modified and saved. All changes are retained in the event of a power cut.

To access the Main Menu press the + and – buttons simultaneously to unlock the display. For full details of menu settings please refer to the guide on page 4 and relevant sections.

6 Storage of Eggs

- 6.1 Store eggs in cool, damp conditions. Most species may be safely stored for up to 14 days before serious reductions in hatch rates are likely. Daily turning of stored eggs also helps maintain hatchability.
- 6.2 Discard cracked, mis-shaped and heavily soiled eggs (if possible). Only wash soiled eggs using a brand egg wash solution such as Brinsea Incubation Disinfectant Concentrate following the manufacturer's instructions. It is essential to wash eggs in solution which is significantly warmer than the egg. Bear in mind that all solutions will remove the outer cuticle from the egg as well as the dirt and may leave the egg at greater risk from bacterial contamination in the future.

7 Temperature

Stable and correct temperature is essential for good results. Adjust with care.

- 7.1 Note: your incubator may not be set to the correct temperature from the factory and the following procedure must be followed before setting eggs.
- 7.2 As the incubator warms up and approaches its control setting the heater on asterisk "*" will change from continuously on to flashing. Allow the incubator to stabilise for at least an hour before adjusting the temperature.
- 7.3 **SETTING THE TEMPERATURE**
Press the - and + buttons simultaneously to unlock the Main Menu.
Press OK to select the temperature screen and adjust as necessary using the + and – buttons.
Press OK to return to the Main Menu and then scroll down to SAVE. Press OK to save the changes.
When reducing temperature the asterisk may go out while the incubator cools – this is normal.
- 7.4 Refer to the digital temperature display to check temperature. The display shows the air temperature in increments of 0.1°. Adjust temperature with care – small differences have large effects on hatching performance.
- 7.5 The Display can be switched to show all temperature settings in degrees Fahrenheit. Press the - and + buttons simultaneously to unlock the main menu. Scroll to the C/F option and press OK to select the C/F display screen. Press the + button to select °F or the – button to select °C. Press OK to return to the Main Menu and then scroll down to Save. Press OK to save the changes.

7.6	Recommended temperatures:			Typical incubation period:
	Hens	37.4 – 37.6°C	99.3 – 99.6°F	21 days
	Pheasant	37.6 – 37.8°C	99.6 - 100°F	23-27 days
	Quail	37.6 – 37.8°C	99.6 - 100°F	16-23 days
	Ducks	37.4 – 37.6°C	99.3 – 99.6°F	28 days
	Parrots:			
	Amazons	36.8 – 37.0°C	98.3 – 98.6°F	24-29 days
	Macaws	36.8 – 37.0°C	98.3 – 98.6°F	26-28 days
	Love birds	36.8 – 37.0°C	98.3 – 98.6°F	22-24 days
	African Grey	36.8 – 37.0°C	98.3 – 98.6°F	28 days
	Eclectus	36.8 – 37.0°C	98.3 – 98.6°F	28 days

7.7 Developing embryos are fairly tolerant of short term temperature drops and the user need not be concerned about cooling that occurs when inspecting eggs. Temperatures above ideal can quickly have a serious detrimental effect on hatch rates and must be avoided.

7.8 The Mini EX has a built-in temperature alarm which warns of high or low temperatures. See section 5 for details.

8 Humidity and Ventilation

Short term variations in humidity are not important. The average humidity over the incubation period needs to be near optimum to achieve the ideal weight loss. High humidity for the day or two of hatching is also important. Beware chronic, excessive humidity.

8.1 Two factors affect incubation humidity: water evaporation within the cabinet (from eggs as well as from additional water) and levels of ventilation. The water content of the air being drawn through the incubator will also have an effect.

8.2 There are two methods available to bird breeders to achieve correct humidity levels:

- a) Monitor humidity levels and adjust to match published guidelines for different species (see below).
- b) Monitor egg weight loss which varies as a direct result of humidity and correct against published weight loss figures for the species.

- a) Generally accepted incubation RH levels for species groups:

During incubation	Poultry	40-50% RH
	Waterfowl	45-55% RH
	Parrots	35-45% RH
Hatching	All species	65% RH or more

For more specific information on particular species' requirements check the relevant literature.

- b) Eggs lose moisture through their shells and the rate of evaporation depends on the humidity levels around the eggs and the shell porosity. During incubation eggs need to lose a fixed amount of water which corresponds to a loss in weight of around 13-16% depending on species. By weighing eggs periodically during incubation it is possible to monitor and, if necessary, correct humidity levels to achieve the correct weight loss.

Weigh the eggs on the day they are set in the incubator, take the average weight and plot this on a graph (see example below). The ideal weight loss line can be plotted by joining the point representing initial average weight with the ideal hatch weight (13-16% less depending on species) with the x-axis representing the incubation period (in days).

By measuring actual average weights every few days the actual weight loss can be plotted and compared to the ideal weight loss line and corrections can be made. For example if the actual weight loss was greater than ideal (see graph below) then the air has been too dry and humidity levels need to be increased to compensate.

Typical ideal weight losses for species groups:

Poultry	13%
Parrots	16%
Waterfowl	14%

Egg weight loss chart

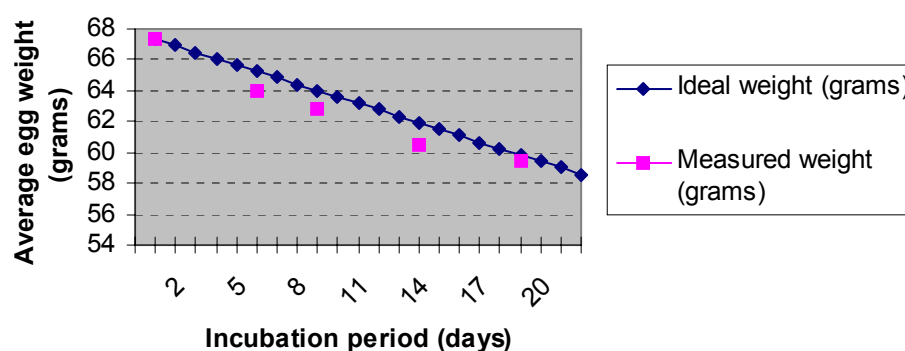

8.3 Of the methods given above the most reliable is egg weight method and is recommended – particularly where poor hatch rates are experienced or if eggs of high value are being incubated.

8.4 SETTING THE RELATIVE HUMIDITY LEVEL

Press the - and + buttons simultaneously to unlock the Main Menu.

Press the + button to scroll to the RH% option.

Press OK to select the RH% screen and adjust as necessary using the + and – buttons.

Press OK to return to the Main Menu and then scroll down to SAVE. Press OK to save the changes.

If the humidity level in the incubator is lower than the Set Humidity Level the pump will start to turn (sometimes brief pulses) and gradually draw water from the tank and pump it to the evaporation card in the incubator. This may take a few hours to pump through and stabilise after which the pump will run intermittently as the humidity level is controlled.

The pump will not run if the incubator is significantly below the set temperature. This is to prevent the system adding too much water when the top has been opened for inspecting eggs etc.

8.5 In all cases the humidity for hatching needs to be high. Because of the short duration involved water/weight loss will not be significantly affected. High humidity is necessary to prevent membranes drying and hardening before the hatch fully emerges. Humidity will naturally increase as the first eggs begin to hatch and internal membranes begin to dry. This is in addition to the water added by the pump.

- 8.6 During hatching the high humidity levels will fall dramatically when the lid is opened and will take some time to build up. Resist the temptation to lift the lid frequently – leave for at least 6 hours between inspections.

The control system may be set to control between 20 and 80% RH. In practice the minimum and maximum levels of humidity achievable in an incubator depend upon several factors including the ambient conditions in the incubation room. You may need to allow 24 hours for humidity to stabilise after making changes.

If you can not achieve the relative humidity level required consider these notes:

- 8.7 **HUMIDITY WILL NOT GO LOW ENOUGH.** The humidity control system can only increase humidity, not actively reduce it. A lower limit will be determined by the moisture content of the ambient air, particularly in warm humid conditions. This can only be countered by dehumidification of the room air outside the incubator with proprietary dehumidifier but is rarely a problem in practice except with ratites.
- 8.8 **HUMIDITY WILL NOT GO HIGH ENOUGH.** Check that water is reaching the incubator when the pump runs – if not check the whole length of the tubing for kinks and check that the tubing around the pump has not become permanently flattened. If it has, replace the pump tube. Silicone tubing is very flexible but can be damaged by sharp finger nails. A tiny perforation on the suction side of the pump will let in air and prevent the pump drawing water.
- 8.9 **CHANGING THE PUMP TUBE.** The peristaltic pump will need to have its tube replaced about every 3 months. Cut a length of tube to about 140mm. Remove the connectors and pull off the old tube. Replace with the new tube, avoiding twists. Use the diagram on the product label to thread the tube exactly as shown over the pump head. The tension must be sufficient to ensure complete occlusion of the tube without unnecessary flattening between the pump rollers. Adjust tube length as necessary. Ensure that the tube does not stick together if left for long periods by unhooking it during storage.

It is normal for some condensation to occur on the cooler exposed parts of the clear top. This natural phenomenon is not a hazard or a problem for incubation.

9 Egg Setting

- 9.1 The Mini EX is designed to accommodate 12 eggs of different sizes up to pheasant eggs or 7 larger eggs using the alternative egg disc.
- 9.2 Before setting eggs ensure that the incubator has been run for several hours and has stabilised at the correct temperature.
- 9.3 Set the eggs in the pockets in the egg disc. Most eggs favour being set with their pointed ends towards the middle of the egg disc (blunt end towards the outside). Some experimentation may be required to check which direction gives the most even turning. Larger eggs typically favour being set with their points towards the outside, especially when using the Large Egg Disc for 7 eggs.
- 9.4 Eggs should rest so that their pointed end is down most of the time. This will happen more naturally as the air space gets larger during incubation. If a particular egg is tending to rest point upwards turn it round to face the other way in the pocket on the egg disc.
- 9.5 Ensure the eggs are clean around their middle as large pieces of dirt may prevent them turning correctly.
- 9.6 Switch the turning system on – see section 10. A revolving line symbol “/” should be shown in the corner of the display.
- 9.7 Once the eggs have been set the temperature must not be adjusted for 24 hours to allow the eggs to warm. Check the water level every 3 days or so and temperature daily. Candle the eggs after 1/3rd of the incubation period has elapsed to reject clear, infertile eggs (see section 14).

10 Egg Turning

The Mini EX turning system has two modes of operation:

- 10.1 ON – The turning system will alternately roll the eggs left and right. A revolving line symbol “/” is shown in the corner of the display.
- 10.2 OFF – The turning system is stopped. This is used for hatching purposes. An “O” will flash in the corner of the display.

The length of time interval between turns may be adjusted and the angle the eggs are turned through may also be adjusted to suit different size eggs. The turning motor runs for a set time and this time (in seconds) can be adjusted to achieve the appropriate turn angle for the eggs.

Larger eggs will require a longer turn to achieve the same angle as smaller ones. Use the chart below for a simple guide. Match the TURN ANG setting to the diameter of the eggs. This should give a turn angle of between 90 and 120 degrees.

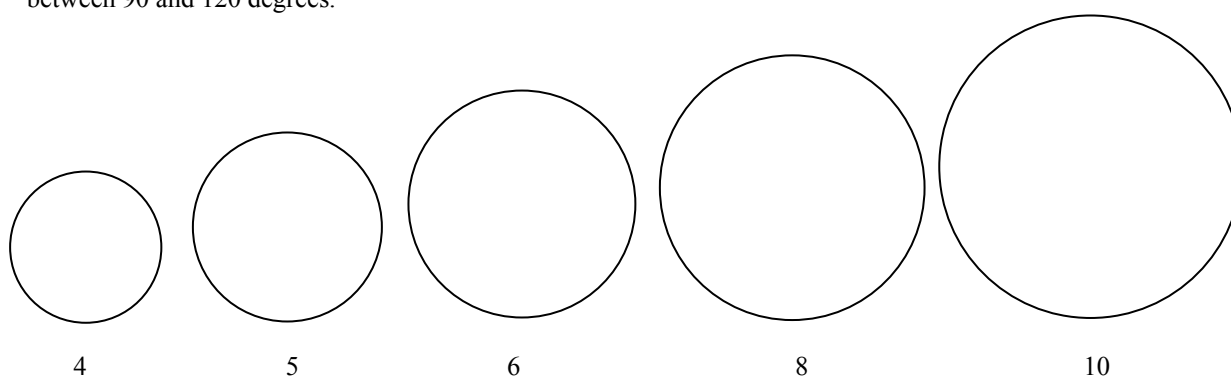

“TURN ANG” setting in Seconds

If eggs of mixed sizes are being incubated it will be necessary to compromise the turning angle. In general, if the larger eggs turn through 90 degrees (1/4 of a turn) then the smaller ones may turn through twice this with no problem. Parrot like species may benefit from larger turns in the first 10 days of incubation.

- 10.3 SETTING THE TURNING OPTIONS (please refer to the menu chart on page 4 for clarity).

Press the - and + buttons simultaneously to unlock the Main Menu.

Press + to scroll to the TURN 0/1 option.

Press OK to select the turning mode screen and use the + and – buttons to set to ON or OFF as required.

Press OK to return to the Main Menu. The TURN INT option will now be displayed. Press OK to select the turn interval screen and use the + and – buttons to set the delay between turns in minutes as required.

Press OK to return to the Main Menu. The TURN ANG option will be displayed. Press OK to select the turn angle screen and use the + and – buttons to set the turning angle timer as appropriate for the size of the eggs.

Press OK to return to the Main Menu and then scroll down to SAVE. Press OK to save the changes.

The turn interval may be set to approximately one hour for most species but parrots' eggs benefit from more frequent turns with 5 or 10 minute intervals for the first 10 days of incubation.

Remember to stop the turning 2 days before the eggs are due to hatch.

11 Hatching

- 11.1 If hatching in the Mini EX remove the egg disc two days before the hatch is due.
- 11.2 Turning must be switched to OFF in the control menu.
- 11.3 Eggs nearing hatch are slightly less sensitive to temperature variation and the hatching temperature can be reduced by up to 1°C (2°F) but this is not essential.
- 11.4 Hatching humidity levels need to be high (see section 8 above).
- 11.5 When most eggs have hatched (12 to 48 hours after the first egg hatches) remove the hatchlings to a brooder. The Brinsea Cosylamp is ideal for poultry and waterfowl etc. The Brinsea TLC-4 Brooder is recommended for exotics.
- 11.6 During hatching the high humidity levels will fall dramatically when the lid is lifted and will take some time to build up. Resist the temptation to open the incubator frequently – leave for at least 6 hours between inspections.

12 Cleaning Up

IMPORTANT:

DISCONNECT THE INCUBATOR FROM THE MAINS POWER SUPPLY DURING CLEANING.

ENSURE THAT ALL ELECTRICAL PARTS ARE KEPT DRY. DO NOT IMMERSE THE INCUBATOR TOP.

- 12.1 NEVER WASH THE BASE, EGG DISCS, COVERS OR CABINET PARTS IN LIQUIDS OVER 50°C (120°F). DO NOT USE A DISHWASHER TO CLEAN EGG DISCS, INCUBATOR BASE OR LID. Following each hatch in the Mini EX remove and wash the egg disc and base in Brinsea Incubation Disinfectant Solution. Wipe all other internal surfaces with a soft cloth soaked in the solution. Ensure that the instructions supplied with the fluid are followed.
- 12.2 Be sure to clean the air vent holes to keep them clear. There are two small holes on the bottom “skirt” of the lid and one on the back of the clear part of the lid above the level of the fan cover.
- 12.3 If a separate hatcher is used the procedure above should still be followed every two months.
- 12.4 Periodically unscrew the four screws retaining the fan cover, remove the cover and soak. Dust and fluff may be removed from the fan and heater cord with a soft brush. USE NO LIQUIDS. DO NOT TURN THE LID OVER AS THE FAN IS NOT FIXED ONCE THE FAN COVER IS REMOVED. The fan should be located on the 4 pegs under the lid before the cover is re-fitted.

THE INCUBATOR MUST NOT BE USED WITHOUT THE FAN COVER FITTED. THE COVER SUPPORTS THE FAN AND PROVIDES PROTECTION FROM THE MOVING BLADES.

- 12.5 The exterior of the incubator and humidity pump may be cleaned with a damp cloth. Avoid allowing any moisture to get inside electrical housings.
- 12.6 ALWAYS CLEAN THE INCUBATOR BEFORE STORAGE AND ENSURE THAT THE UNIT IS TOTALLY DRY INSIDE AND OUT. ALLOW IT TO RUN FOR 24 HOURS WITH NO WATER IN TO ENSURE IT IS THOROUGHLY DRY.

13 Servicing and Calibration

- 13.1 In case of failure first check that the mains Power Supply Unit is fully engaged in the socket and that its lead and plug are fully engaged in the correct socket in the top of the incubator. The digital control system may be reset to the original factory defaults by connecting the power supply while holding the OK button. Check temperature calibration after resetting to defaults.

If the problem persists contact your distributor or Brinsea Products Service Dept.

- 13.2 The functional parts of the Mini EX are modular and parts are available and are readily exchanged by a suitably qualified person equipped with basic tools. Fitting instructions are supplied with replacement parts.
- 13.3 The digital temperature display is individually calibrated during manufacture but may be re-calibrated if required. To ensure optimal performance return the incubator to Brinsea Products Service dept. for re-calibration every two years. It is not recommended that this procedure is carried out by the user.

BE CAUTIOUS OF LOW COST ANALOGUE OR DIGITAL THERMOMETERS AND HYGROMETERS. BRINSEA PRODUCTS LTD USES SOPHISTICATED EQUIPMENT TRACEABLE TO INTERNATIONAL REFERENCE STANDARDS.

To access the Calibration Menu press all three buttons simultaneously to unlock the display.

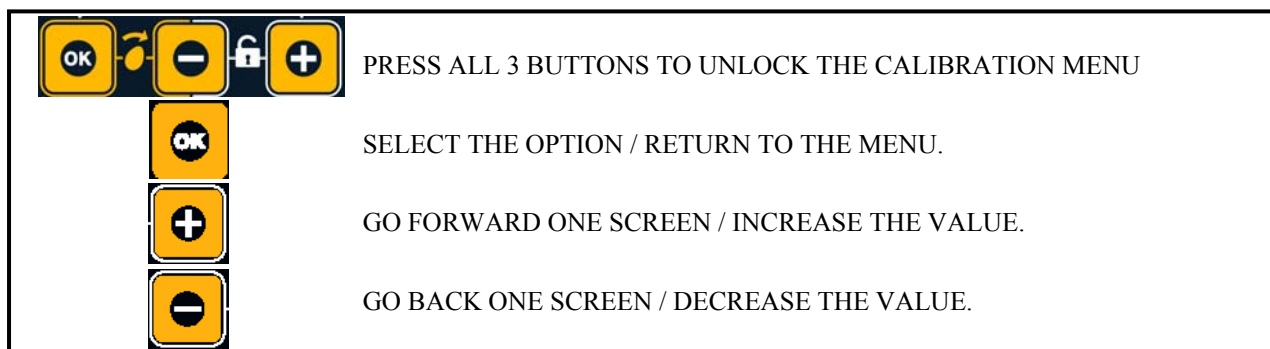

CALIBRATION MENU

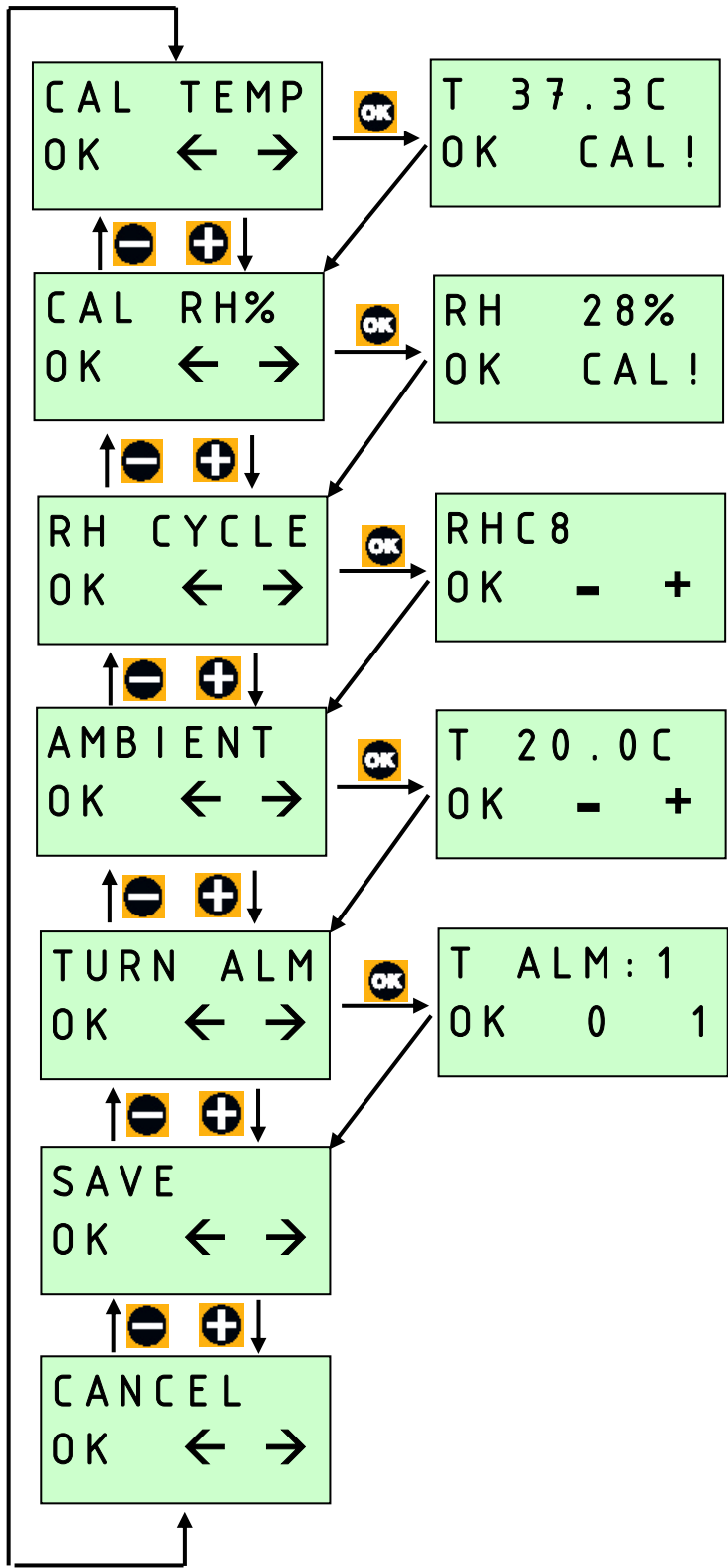

CALIBRATE THERMOMETER.
TAKE A READING 20mm ABOVE THE CENTRE OF SEVERAL EGG POCKETS ON THE EGG DISC AND CALCULATE THE AVERAGE.

CALIBRATE HYGROMETER.
TAKE A READING 20mm ABOVE THE EGG DISC WITH NO WATER IN THE POTS.

HUMIDITY PUMP CYCLE TIME.
ADJUSTS THE RATIO OF PUMP ON TO PUMP OFF TIMES. ONLY ADJUST IF DISPLAY VARIES BY MORE THAN +/- 3%RH.

AMBIENT TEMPERATURE COMPENSATION.
AMBIENT TEMPERATURE USED IN HEATER CONTROL ALGORITHM. ONLY ADJUST IF DISPLAY VARIES BY MORE THAN +/- 0.2°C.

TURN ALARM.
SWITCHES THE TURN WARNING ALARM OFF IF CAUSING A DISTURBANCE.

14 Troubleshooting

- 14.1 Poor hatching results are frustrating and can be caused by a large number of factors. The most common are given below. Brinsea Products will not be held responsible for loss of eggs or chicks under any circumstances. However we will try to advise on incubation technique to improve results where necessary.
- 14.2 Gather as much information from the hatching results as possible to enable the problem to be analysed in detail. Record dates that eggs are set, incubator settings, dates of hatches, weight losses and the number and condition of hatchlings. Candle or break open unhatched eggs to estimate the extent of embryo development. The Brinsea Cool-Lume or Egg-Lume candling lamps are available from your dealer.

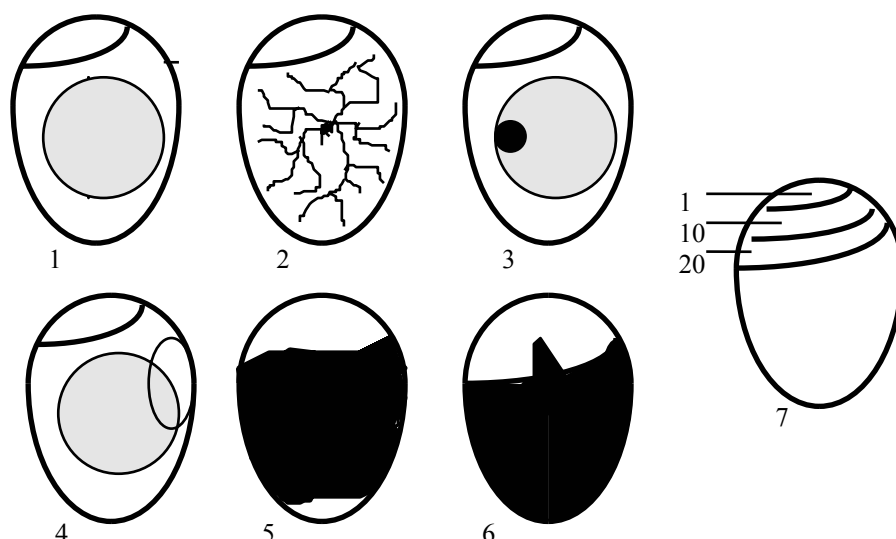

- 1) Clear when candled - probably infertile (or very early death) when candled at 8 days
- 2) Fertile with red blood vessels - after 8 days
- 3) Red or black staining - early death when candled at 8 days
- 4) Embryo with red blood 'ring' - early death when candled at 8 days
- 5) Dark outline with ill defined detail - late death (10-16 days)
- 6) Live embryo with bill in air sack - due to hatch in 24-48 hours
- 7) Normal development of the air pocket according to number of days

General guides:

Observation	Likely Cause(s)	Solution(s)
No chicks hatch	Infertility, infection, drastically incorrect incubation settings, parent ill health.	Check egg viability – are similar eggs hatching naturally. Disinfect the incubator. Check incubator settings and procedures – particularly temperature.
Chicks hatch earlier than expected, deformities.	Incubation temperature too high	Reduce incubation temperature slightly 0.5°C (1°F)
Chicks hatch later than expected	Incubation temperature too low	Raise incubation temperature slightly 0.5°C (1°F)
Hatch dates widely spread	Different rates of development due to different storage times, incubation temperature variation.	Limit egg storage times. Check for incubation temperature variation – sunlight, large room variation etc.
Late stage 'death in shell'	Incorrect humidity, probably too high.	Try reducing average humidity levels (but see section 8 above)
Generally poor results	Incorrect incubation settings, poor parent bird health, inadequate egg turning,	Improve parent bird health, check all incubation settings, analyse egg weight loss to confirm humidity correct, check turning working correctly.

15 Specification

Mini Advance EX Maximum Setting Capacities:

Egg size	Typical capacity
Quail	12
Pheasant	12
Amazon/Macaw	7
Hen	7
Duck	7

INCUBATOR

Dimensions:	22cm x 22cm x 16.5cm high
Weight:	0.89 Kg
Power Consumption:	
Incubator maximum	18 Watts
(typical average)	12 Watts
Power Supply Unit:	100 - 230v, 50Hz, 0.5A max.

HUMDITY PUMP

Sensor:	Sensor accuracy +/- 3%. Hysteresis 0% R.H Response time less than 4 seconds
Water Transfer:	In-built peristaltic pump Maximum water flow rate 30g/hour
Tank Capacity:	1L
Control setting and metering:	Indicated in % RH
Dimensions:	15cm x 12.5cm x 14cm (W x D x H)
Weight (dry):	0.6 Kg

Registered Community Design Application No 001130082

Brinsea Products Ltd, Station Road, Sandford, N. Somerset, BS25 5RA
 Tel: 0845 226 0120 Fax: (01934) 820250
 e-mail: sales@brinsea.co.uk, website: www.Brinsea.co.uk